

PROJECT NO:

XXX

REV	DESCRIPTION	DATE	APPROVED
S0	CREATED DRAWING	2018/01/28	CRB
S1	ADD 7PIN MATERIAL NUMBER	2024/08/28	ZCH

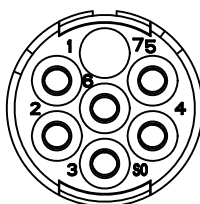

SCALE:3:1
DETAIL A
6PIN

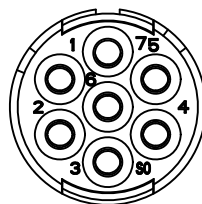

SCALE:3:1
DETAIL A
7PIN

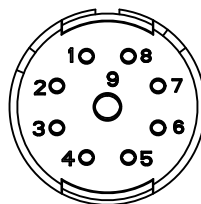

SCALE:3:1
DETAIL A
9(8+1)PIN

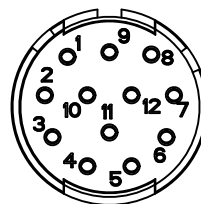

SCALE:3:1
DETAIL A
12PIN

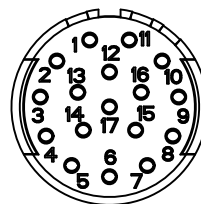

SCALE:3:1
DETAIL A
17PIN

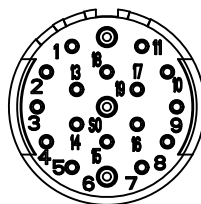

SCALE:3:1
DETAIL A
19(16+3)PIN

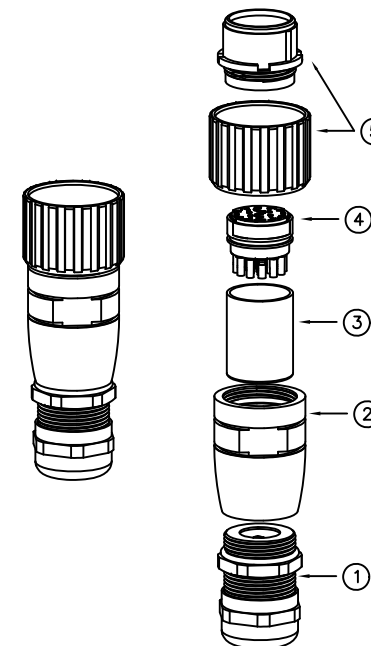
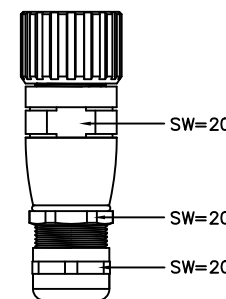
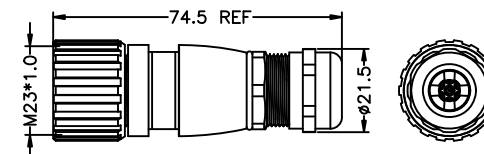
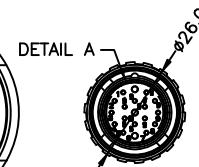

ORDER NO.	ITEM ④	APPLICABLE WIRE	RATING VOLTAGE	RATING CURRENT
230006-02-001	6PIN FEMALE INSERT	2.5mm ² (14AWG)	250V AC/DC	20A
230007-02-001	7PIN FEMALE INSERT	2.5mm ² (14AWG)	250V AC/DC	20A
230009-02-001	9PIN FEMALE INSERT	1.5+2.5mm ² (16+14AWG)	250V AC/DC	8A+20A
230012-02-001	12PIN FEMALE INSERT	1.0mm ² (18AWG)	150V AC/DC	8A
230017-02-001	17PIN FEMALE INSERT	1.0mm ² (18AWG)	150V AC/DC	8A
230019-02-001	19PIN FEMALE INSERT	1.0+1.5mm ² (18+16AWG)	150V AC/DC	8A+10A

Detailed Product Description:
Waterproof connector rating is IP67
They can not be used permanently under water.

Connector Electrical character
Rating voltage: SEE TABLE
Insulation resistance: >100MΩ
Rating current : SEE TABLE
Contact resistance of connector ≤5mΩ
Mechanical characteristics:
mating / cycle >500 cycle
Operating temperature: -40°C ~ +115°C
Design from DIN EN60664 AND DIN EN61984
Cable OD: Ø3mm-Ø9.5mm

*ALL MATERIALS ARE RoHS COMPLIANT.

⑤	CN00499	M23 LOCK NUT	1	SET
④	SEE TABLE	M23 FEMALE INSERT	1	SET
③	CN00493	M23 PLASTIC PART INSIDE	1	PCS
②	CN00508	M23 MAIN BODY	1	SET
①	CN00492	M23 CABLE GLAND	1	SET

ITEM	PART NO.	SPECIFICATION	Q'TY	UNIT
------	----------	---------------	------	------



SIGNAL®

Shen Zhen Signal Electronics co.,Ltd

TITLE M23 FEMALE HEAD METAL ASSEMBLY (M23*1.0)

SGN NO SEE TABLE

DWG NO

CUSTOMER

TOLERANCES ARE:
DECIMALES ANGLES
.x ±0.5 x.' ±2.0'
.xx ±0.20 .x' ±1.0'

THIRD ANGLE PROJECTION

SIZE: A4 UNITS: mm
SCALE: 1:1 SHEET: 1 OF 1

DRAWN BY

CHECKED BY

APPROVED BY

DATE

DATE

DATE

REV.

S1

THE INFORMATION CONTAINED IN THIS DRAWING IS THE SOLE PROPERTY OF SIGNAL COMPANY.
ANY REPRODUCTION IN PART OR WHOLE WITHOUT THE WRITTEN PERMISSION OF SIGNAL COMPANY IS PROHIBITED.